

ORDERING INFORMATION

Device	Temperature Range	Package
MC1310P	-40°C to +85°C	Plastic DIP

MC1310

Specifications and Applications Information

FM STEREO DEMODULATOR

- a monolithic device designed for use in solid-state stereo receivers.
- Requires no Inductors
- Low External Part Count
- Only Oscillator Frequency Adjustment Necessary
- Integral Stereo/Monaural Switch 75 mA Lamp Driving Capability
- Wide Dynamic Range: 0.5–2.8 V (p-p) Composite Input Signal
- Wide Supply Range: 8–14 Vdc
- Excellent Channel Separation Maintained Over Entire Audio Frequency Range
- Low Distortion: Typically 0.3% THD at 560 mV (RMS) Composite Input Signal
- Excellent SCA Rejection

FM STEREO DEMODULATOR

SILICON MONOLITHIC INTEGRATED CIRCUIT

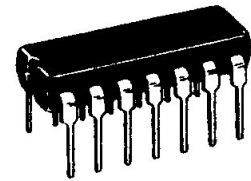

CASE 646

FIGURE 1 – TYPICAL APPLICATION AND TEST CIRCUIT

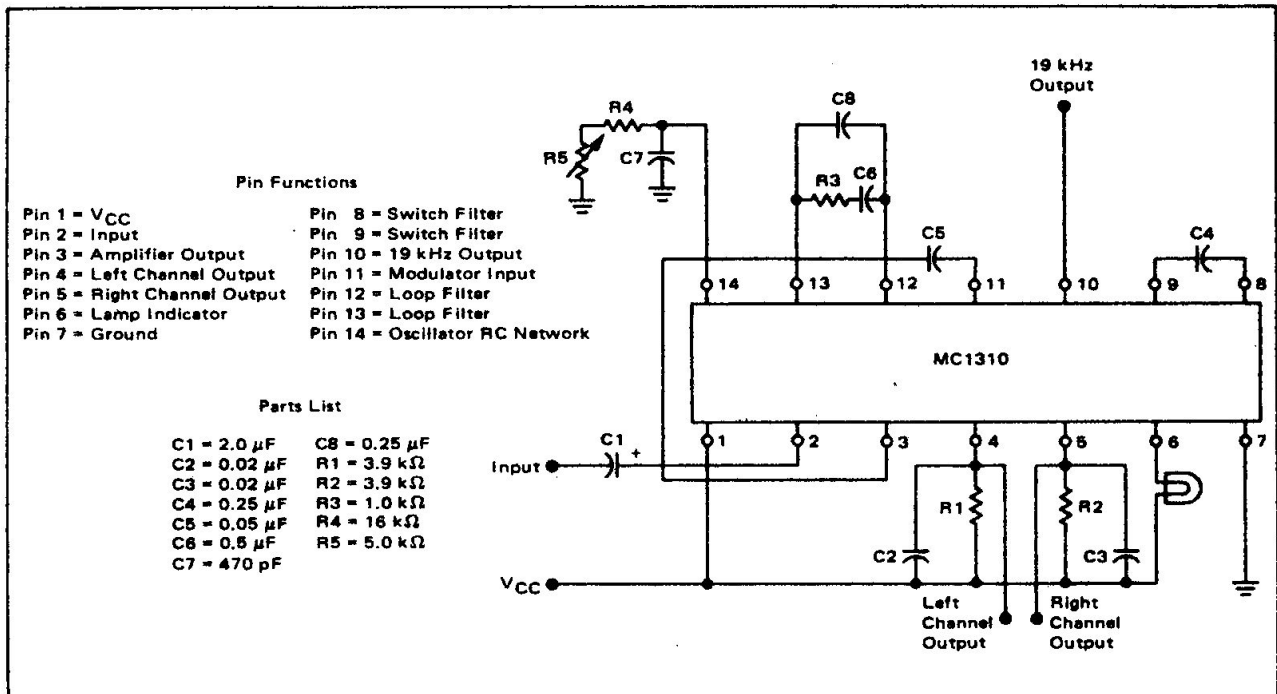

MC1310

MAXIMUM RATINGS (T_A = +25° unless otherwise noted.)

Rating	Value	Unit
Power Supply Voltage	14	Volts
Lamp Current	75	mA
Power Dissipation (Package limitation) Derate above T _A = +25°C	625 5.0	mW mW/°C
Operating Temperature Range (Ambient)	-40 to +85	°C
Storage Temperature Range	-65 to +150	°C

ELECTRICAL CHARACTERISTICS Unless otherwise noted; V_{CC} = +12 Vdc, T_A = +25°C, 560 mV(RMS) (2.8 V_[p-p]) standard multiplex composite signal with L or R channel only modulated at 1.0 kHz and with 100 mV(RMS) pilot level (10%), using circuit of Figure 1.

Characteristic	Min	Typ	Max	Unit
Maximum Standard Composite Input Signal (0.5% THD)	2.8	—	—	V _[p-p]
Maximum Monaural Input Signal (1.0% THD)	2.8	—	—	V _[p-p]
Input Impedance	20	50	—	kΩ
Stereo Channel Separation	30	40	—	dB
Audio Output Voltage (desired channel)	—	485	—	mV(RMS)
Monaural Channel Balance (pilot tone "off")	—	—	1.5	dB
Total Harmonic Distortion	—	0.3	—	%
Ultrasonic Frequency Rejection	19 kHz 38 kHz	34.4 45	— —	dB
Inherent SC A Rejection (f = 67 kHz; 9.0 kHz beat note measured with 1.0 kHz modulation "off")	—	75	—	dB
Stereo Switch Level 19 kHz input level for lamp "on" 19 kHz input level for lamp "off"	— 5.0	— —	20 —	mV(RMS)
Capture Range (permissible tuning error of internal oscillator, reference circuit values of Figure 1)	—	±3.5	—	%
Current Drain (lamp "off")	—	13	—	mAdc

TYPICAL CHARACTERISTICS

Unless otherwise noted: $V_{CC} = +12$ Vdc, $T_A = +25^{\circ}\text{C}$; 560 mV(RMS) (2.8 V_[p-p]) standard multiplex composite signal with L or R channel only modulated at 1.0 kHz and with 100 mV(RMS) pilot level (10%), using circuit of Figure 1.

FIGURE 3 – CHANNEL SEPARATION versus COMPOSITE INPUT LEVEL

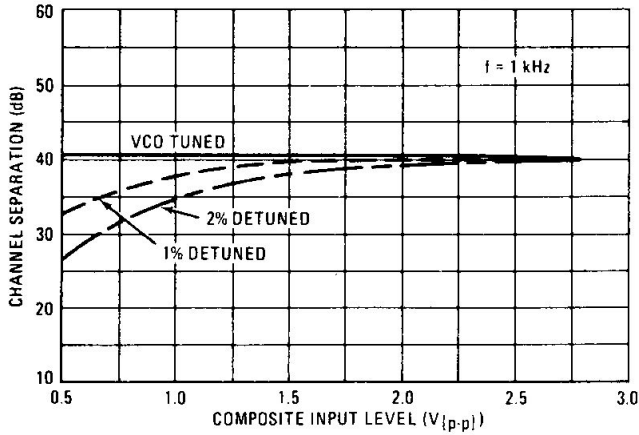

FIGURE 4 – CHANNEL SEPARATION versus FREQUENCY

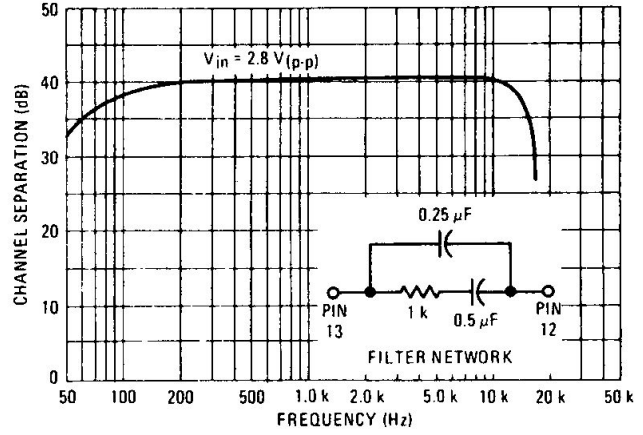

FIGURE 5 – CHANNEL SEPARATION versus VCO FREE-RUNNING FREQUENCY

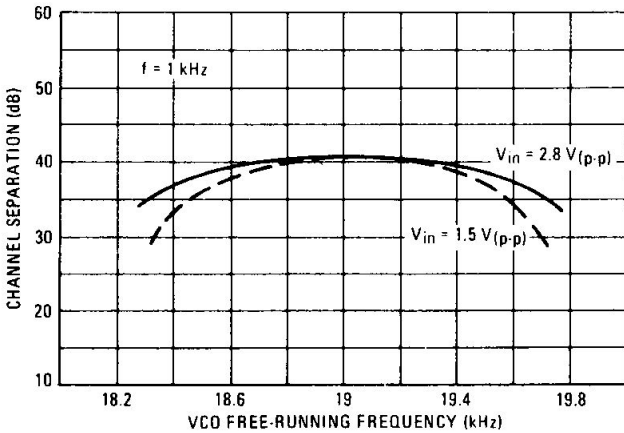

FIGURE 6 – CHANNEL SEPARATION versus SUPPLY VOLTAGE

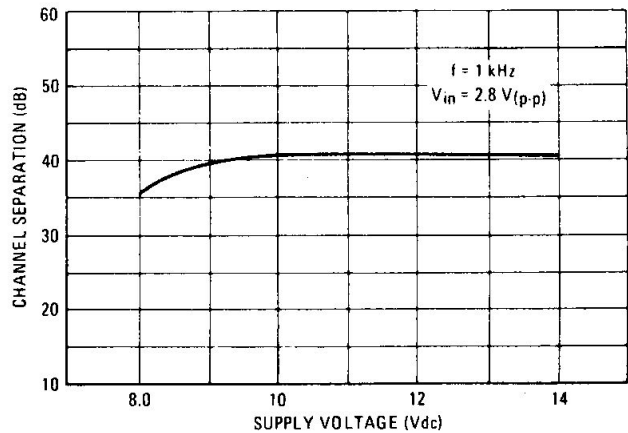

FIGURE 7 – THD versus COMPOSITE INPUT LEVEL*

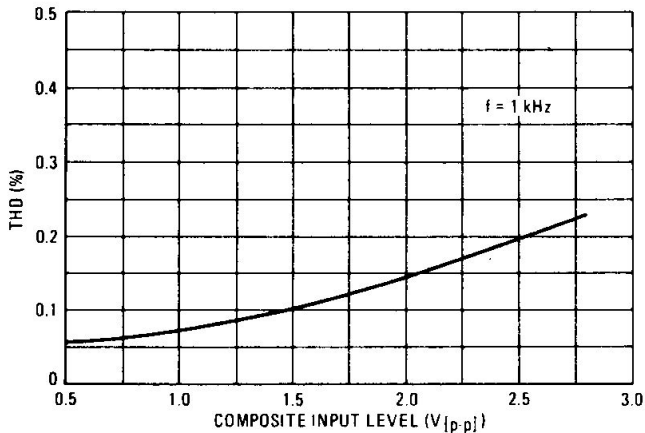
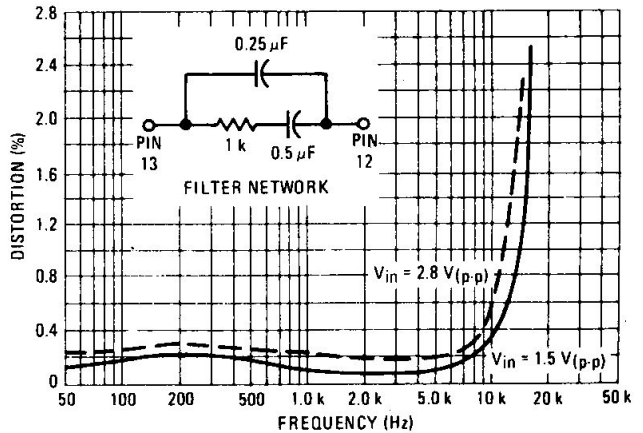

FIGURE 8 – DISTORTION versus FREQUENCY*



*Measured with Low Pass Filter (BW = 15 kHz).

TYPICAL CHARACTERISTICS (continued)

FIGURE 9 – DISTORTION versus FREQUENCY*

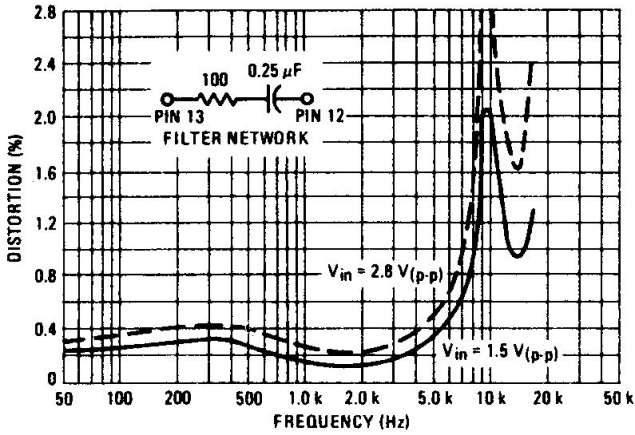

FIGURE 10 – VCO FREE-RUNNING FREQUENCY versus TEMPERATURE

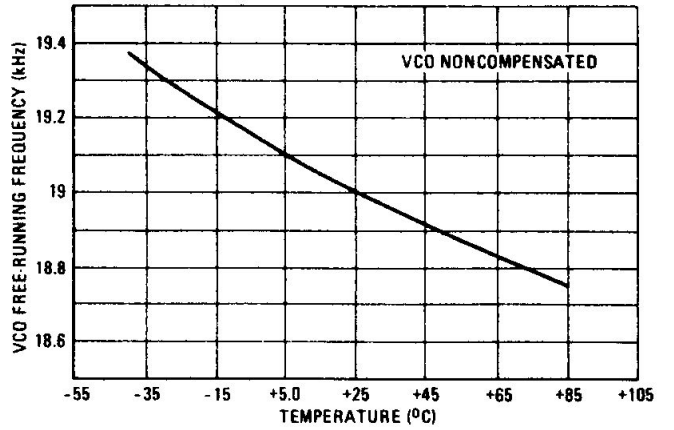

FIGURE 11 – CURRENT DRAIN versus SUPPLY VOLTAGE

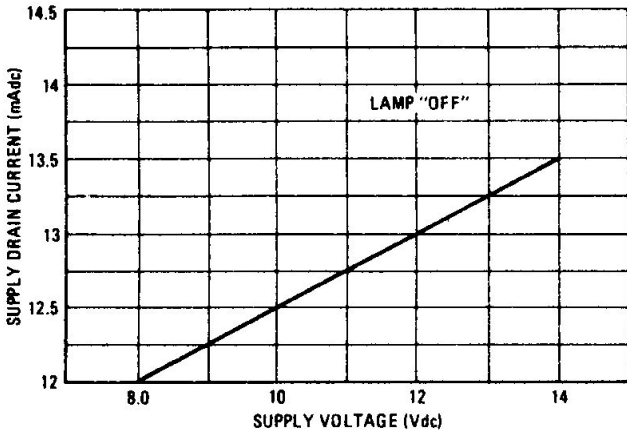
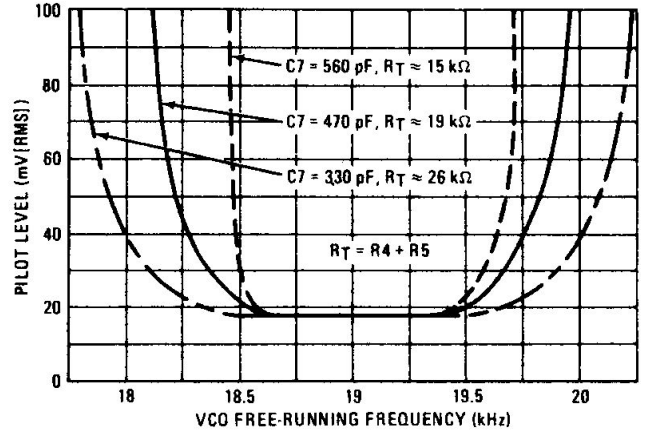
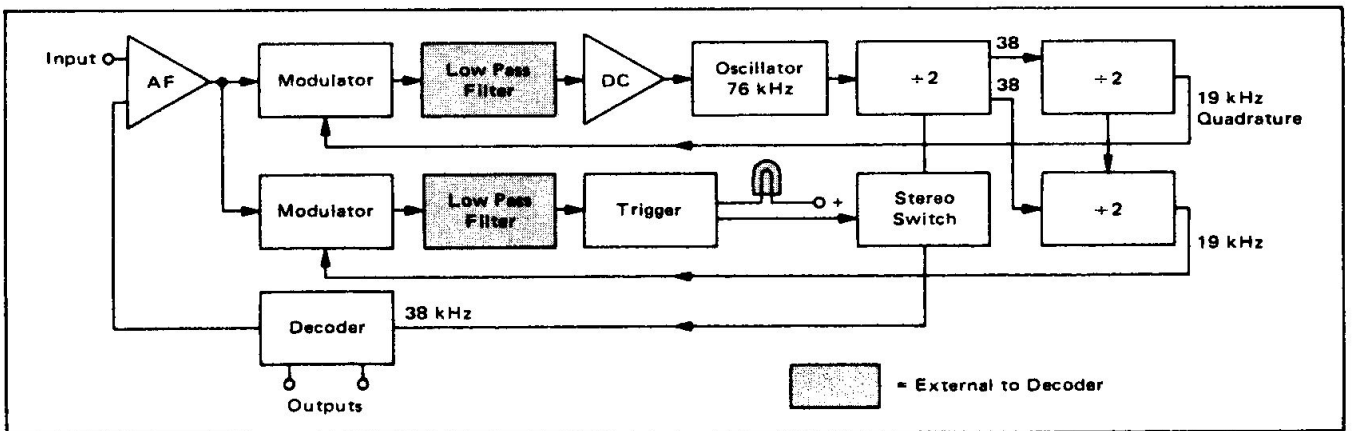

FIGURE 12 – PILOT LEVEL REQUIRED FOR VCO LOCKUP versus VCO FREE-RUNNING FREQUENCY



*Measured with Low Pass Filter (BW = 15 kHz)

FIGURE 13 – SYSTEM BLOCK DIAGRAM



CIRCUIT OPERATION

Figure 13, on the previous page, shows the system block diagram. The upper line, comprising the 38-kHz regeneration loop operates as follows: the internal oscillator running at 76-kHz and feeding through two divider stages returns a 19-kHz signal to the input modulator. There the returned signal is multiplied with the incoming signal so that when a 19-kHz pilot tone is received a dc component is produced. The dc component is extracted by the low pass filter and used to control the frequency of the internal oscillator which consequently becomes phase-locked to the pilot tone. With the oscillator phase-locked to the pilot the 38-kHz output from the first divider is in the correct phase for decoding a stereo signal. The decoder is essentially another modulator in which the incoming signal is multiplied by

the regenerated 38-kHz signal. The regenerated 38-kHz signal is fed to the stereo decoder via an internal switch, which closes when a sufficiently large 19 kHz pilot tone is received.

The 19-kHz signal returned to the 38-kHz regeneration loop modulator is in quadrature with the 19-kHz pilot tone when the loop is locked. With the third divider state appropriately connected, a 19-kHz signal in phase with the pilot tone is generated. This is multiplied with the incoming signal in the stereo switch modulator yielding a dc component proportional to the pilot tone amplitude. This component after filtering is applied to the trigger circuit which activates both the stereo switch and an indicator lamp.

APPLICATIONS INFORMATION

(Component numbers refer to Figure 1)

External Component Functions and Values

- C1 Input coupling capacitor; 2.0 μ F is recommended but a lower value is permissible if reduced separation at low frequencies is acceptable.
- R1, R2, C2, C3 See Maximum Load Resistance section.
- C4 Filter capacitor for stereo switch level detector; time constant is $C4 \times 53$ kilohms $\pm 30\%$, maximum dc voltage appearing across C4 is 0.25 V (pin 8 positive) at 100 mV(RMS) pilot level. The signal voltage across C4 is negligible.
- C5 See Phase Compensation section.
- R3, C6, C8 Phase-locked loop filter components; the following network is recommended:

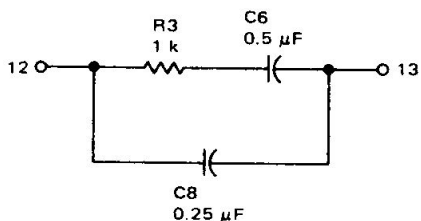

When less performance is required a simpler network consisting of $R3 = 100$ ohms and $C6 = 0.25 \mu F$ may be used (omit C8). See Figure 9.

- R4, R5, C7 Oscillator timing network; recommended values:
 C7 = 470 pF 1%
 R4 = 16 k Ω 1%
 R5 = 5 k Ω Preset

These values give $\pm 3.5\%$ typical capture range. Capture range may be increased by reducing C7 and increasing R4, R5 proportionally but at the cost of increasing beat-note distortion (due to oscillator-phase jitter) at high-signal levels. See Figure 12.

- Stereo Lamp Nominal rating up to 75 mA at 12 V; the circuit includes surge limiting which restricts cold-lamp current to approximately 250 mA.
- 19-kHz Output A buffer output providing a 3.0-V_{pk} square wave at 19 kHz is available at pin 10. A frequency counter may be connected to this point to measure the oscillator free-running frequency for alignment. See Alignment section.

External Monaural/Stereo Switching

If it is desired to maintain the circuit in monaural mode, the following procedure must be followed. First, the stereo switch must be disabled to prevent false lamp triggering. This can be accomplished by connecting pin 8 negative or pin 9 positive by 0.3 volt. Pin 8 may be grounded directly if desired. Note that the voltage across C4 increases to approximately 2 volts with pin 9 positive when pin 8 is grounded.

Second, the 76-kHz oscillator must be killed to prevent interference when on AM. This can be accomplished by connecting pin 14 to ground via a current limiting resistor (3.3 kilohms is recommended).

Phase Compensation/IF Roll-off Compensation

Phase-shifts in the circuit cause the regenerated 38-kHz sub-carrier to lead the original 38 kHz by approximately 2° . The coupling capacitor C5 generates an

APPLICATIONS INFORMATION (continued)

additional lead of 3.5° (for $C5 = 0.05 \mu\text{F}$) giving a total lead of 5.5° .

The circuit is so designed that phase lag may be generated by adding a capacitor from pin 3 to ground. The source resistance at this point is 500 ohms. A capacitance of 820 pF compensates the 5.5° phase lead: increase above this value causes the regenerated sub-carrier to lag the original. However, a 5.5° phase error if left noncompensated will not degrade separation appreciably.

Note that these phase shifts occur within the phase-locked loop and affect only the regenerated 38-kHz sub-carrier: the circuit causes no significant phase or amplitude variation in the actual stereo signal prior to decoding.

Most IF amplifiers have a frequency response that limits separation to a value significantly lower than the capability of the MC1310. For example, if the response produces a 1-dB roll-off at 38 kHz, the separation will be limited to about 32 dB. This error can be compensated by using an RC lead network as shown in Figure 14. The exact values will be determined by the IF amplifier design. However, the values shown in Figure 14 are suitable for use with the MC1357 and MC1375 IF amplifiers.

FIGURE 14 – IF COMPENSATION NETWORK

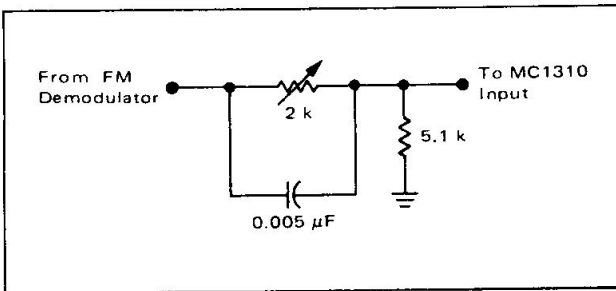

Voltage Control Oscillator Compensation

Figure 10 illustrates noncompensated Oscillator Drift versus temperature. The recommended T_C of the R4, R5, C7 combination is -300 PPM. This will hold the oscillator drift to approximately $\pm 1\%$ over a temperature range of -40 to $+85^\circ\text{C}$. Allowing $\pm 2\%$ for aging of the timing components acceptable performance is still obtained.

Lamp Sensitivity

It may be desirable in some cases, to change the lamp sensitivity due to differing signal levels produced by various FM detectors. The lamp sensitivity can be changed by making use of the external circuit shown. Typical sensitivities versus potentiometer rotation are also shown in Figure 15.

FIGURE 15 – PILOT SENSITIVITY versus POTENTIOMETER ROTATION

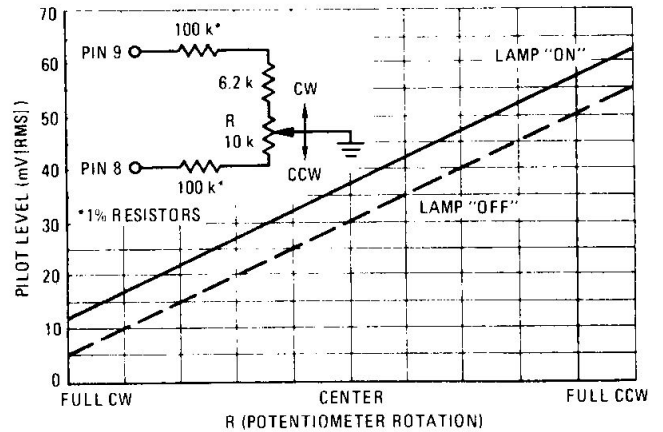

Alignment Procedure

The optimum alignment procedure, with no input signal applied, is to adjust R5 until 19.00 kHz is read at pin 10 on the frequency counter.

Another procedure requiring no equipment, other than the receiver itself, will result in separation of within a few dB of optimum. This latter method is merely to tune the receiver to a stereo broadcast and adjust R5 until the pilot lamp turns "on". To find the center of the lock-in range, rotate the potentiometer back and forth until the center of the lamp "on" range is found. This completes the alignment.

Alternate Timing Network

The alternate timing network shown, incorporating a trimmer capacitor rather than a potentiometer, may be used if desired. Again, to provide correct temperature compensation, the temperature coefficient of the timing network must be approximately -300 PPM.

FIGURE 16

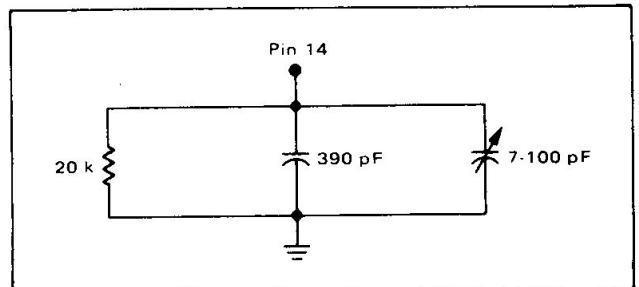

Maximum Load Resistance

The curve shown gives absolute maximum load resistance values versus supply voltage used for full-signal handling capability. With desired load resistance choose C2, C3 capacitors to provide standard 75 μs de-emphasis.

APPLICATIONS INFORMATION (continued)

FIGURE 17 – MAXIMUM LOAD RESISTANCE versus SUPPLY VOLTAGE

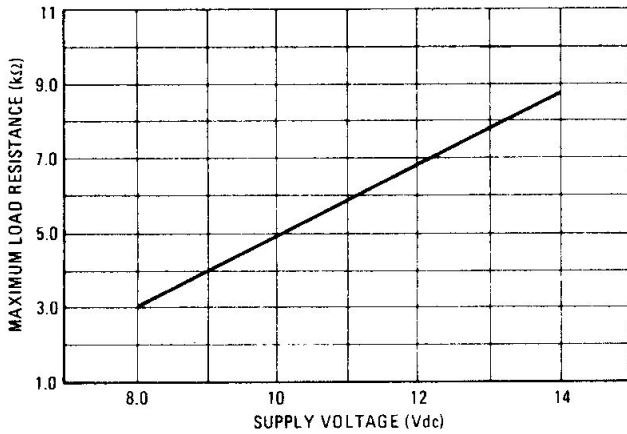

Audio Output

The ratio $G = \frac{\text{p-p audio output (one-channel)}}{\text{p-p input signal}}$ for

different types of input is as follows:

INPUT	
Single-Channel Composite Signal	Monaural Signal
0.45	0.5

These figures are for 3.9-kilohm load resistors and for low-audio frequencies where de-emphasis roll-off is insignificant.

Capture Range versus Timing Components

The capture range can be changed to some extent by use of different timing components. Typical values are shown in Figure 12.

Composite Signal

Due to confusion concerning the measurement of the stereo composite signal, a curve showing both RMS and p-p composite levels versus pilot level follows, see Figure 18.

FIGURE 18 – COMPOSITE LEVEL versus PILOT (L or R Modulation Only)

