

Operational Transconductance Amplifier (OTA)

May 1993

Features

- Slew Rate (Unity Gain, Compensated) 50V/ms
- Adjustable Power Consumption 10 μ W to 30 μ W
- Flexible Supply Voltage Range \pm 2V to \pm 15V
- Fully Adjustable Gain 0 to gm_RL Limit
- Tight g_M Spread:
 - CA3080 2:1
 - CA3080A 1.6:1
- Extended g_M Linearity 3 Decades

Applications

- Sample and Hold
- Multiplexer
- Voltage Follower
- Multiplier
- Comparator

Ordering Information

PART NUMBER	TEMP. RANGE	PACKAGE
CA3080	0°C to +70°C	8 Pin Can
CA3080A	-55°C to +125°C	8 Pin Can
CA3080AE	-55°C to +125°C	8 Lead Plastic DIP
CA3080AM	-55°C to +125°C	8 Lead SOIC
CA3080AM96	-55°C to +125°C	8 Lead SOIC*
CA3080E	0°C to +70°C	8 Pin Can
CA3080M	0°C to +70°C	8 Lead SOIC
CA3080M96	0°C to +70°C	8 Lead SOIC*

* Denotes Tape and Reel

Description

The CA3080 and CA3080A types are Gatable-Gain Blocks which utilize the unique operational-transconductance-amplifier (OTA) concept described in Application Note ICAN-6668, "Applications of the CA3080 and CA3080A High-Performance Operational Transconductance Amplifiers".

The CA3080 and CA3080A types have differential input and a single-ended, push-pull, class A output. In addition, these types have an amplifier bias input which may be used either for gating or for linear gain control. These types also have a high output impedance and their transconductance (g_M) is directly proportional to the amplifier bias current (I_{ABC}).

The CA3080 and CA3080A types are notable for their excellent slew rate (50V/ μ s), which makes them especially useful for multiplexer and fast unity-gain voltage followers. These types are especially applicable for multiplexer applications because power is consumed only when the devices are in the "ON" channel state.

The CA3080A is rated for operation over the full military-temperature range (-55°C to +125°C) and its characteristics are specifically controlled for applications such as sample-hold, gain-control, multiplex, etc. Operational transconductance amplifiers are also useful in programmable power-switch applications, e.g., as described in Application Note AN6048, "Some Applications of a Programmable Power Switch/Amplifier" (CA3094, CA3094A, CA3094B).

Pinouts CA3080 (PDIP, SOIC) TOP VIEW

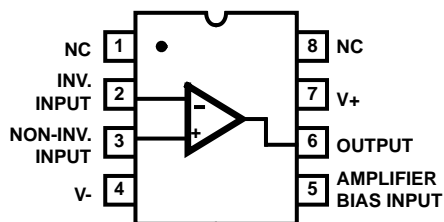

CA3080 (TO-5 CAN) TOP VIEW

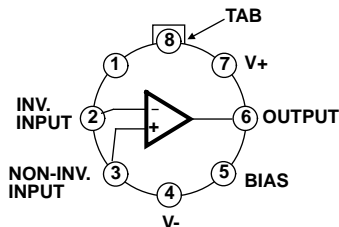

NOTE: Pin 4 is connected to case.

Schematic Diagram

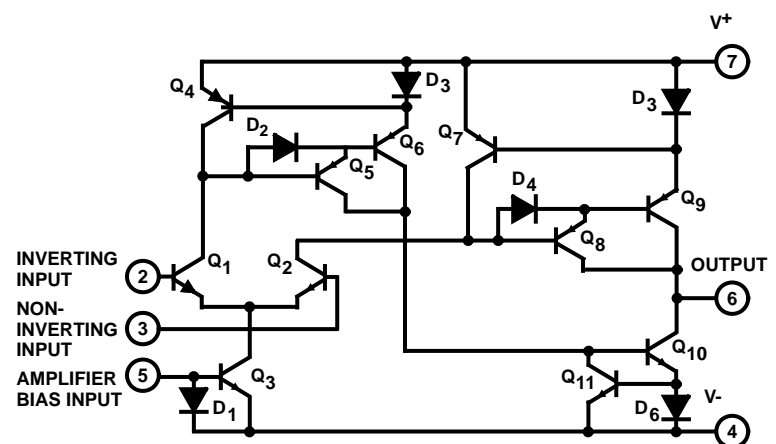

Specifications CA3080, CA3080A

Absolute Maximum Ratings

Supply Voltage (Between V+ and V- Terminal)	36V
Differential Input Voltage	5V
Input Voltage	V+ to V-
Input Signal Current	1mA
Amplifier Bias Current (I_{ABC})	2mA
Power Dissipation	125mW
Output Short Circuit Duration (Note 1)	No Limitation
Junction Temperature	+175°C
Junction Temperature (Plastic Package)	+150°C
Lead Temperature (Soldering 10 Sec.)	+300°C

Operating Conditions

Operating Temperature Range	0°C to +70°C
CA3080	0°C to +70°C
CA3080A	-55°C to +125°C
Storage Temperature Range	-65°C to +150°C

CAUTION: Stresses above those listed in "Absolute Maximum Ratings" may cause permanent damage to the device. This is a stress only rating and operation of the device at these or any other conditions above those indicated in the operational sections of this specification is not implied.

Electrical Specifications For Equipment Design, $T_A = +25^\circ\text{C}$, Unless Otherwise Specified

PARAMETERS	SYMBOL	TEST CONDITIONS	CA3080 LIMITS			UNITS
		V+ = 15V, V- = -15V $I_{ABC} = 500\mu\text{A}$	MIN	TYP	MAX	
Input Offset Voltage	V_{IO}		-	0.4	5	mV
		$T_A = 0$ to $+70^\circ\text{C}$	-	-	6	mV
Input Offset Current	I_{IO}		-	0.12	0.6	μA
Input Bias Current	I_I		-	2	5	μA
		$T_A = 0$ to $+70^\circ\text{C}$	-	-	7	μA
Forward Transconductance (Large Signal)	g_M		6700	9600	13000	μmho
		$T_A = 0$ to $+70^\circ\text{C}$	5400	-	-	μmho
Peak Output Current	I_{OM}	$R_L = 0\Omega$	350	500	650	μA
		$R_L = 0\Omega, T_A = 0$ to $+70^\circ\text{C}$	300	-	-	μA
Peak Output Voltage:	V_{+OM}	$R_L = \infty$				
			Positive	12	13.5	-
	V_{-OM}	$R_L = \infty$				
Negative			-12	-14.4	-	V
Amplifier Supply Current	I_A		0.8	1	1.2	mA
Device Dissipation	P_D		24	30	36	mW
Input Offset Voltage Sensitivity:	$\Delta V_{IO}/\Delta V_+$					
			Positive	-	-	150
	$\Delta V_{IO}/\Delta V_-$					
Negative			-	-	150	$\mu\text{V}/\text{V}$
Common-Mode Rejection Ratio	CMRR		80	110	-	dB
Common-Mode Input-Voltage	V_{ICR}		12 to -12	13.6 to -14.6	-	V
Input Resistance	R_I		10	26	-	k Ω

NOTE:

1. Short circuit may be applied to ground or to either supply.

Specifications CA3080, CA3080A

Electrical Specifications Typical Values Intended Only for Design Guidance, $T_A = +25^\circ\text{C}$, Unless Otherwise Specified

PARAMETERS	SYMBOL	TEST CONDITIONS	CA3080 TYP	UNITS
		$V_+ = 15\text{V}, V_- = -15\text{V}$ $I_{ABC} = 500\mu\text{A}$		
Input Offset Voltage	V_{IO}	$I_{ABC} = 5\mu\text{A}$	0.3	mV
Input Offset Voltage Change	ΔV_{IO}	$I_{ABC} = 500\mu\text{A}$ to $I_{ABC} = 5\mu\text{A}$	0.2	mV
Peak Output Current	I_{OM}	$I_{ABC} = 5\mu\text{A}$	5	μA
Peak Output Voltage:		$I_{ABC} = 5\mu\text{A}$		
Positive	V_{+OM}		13.8	V
Negative	V_{-OM}		-14.5	V
Magnitude of Leakage Current		$I_{ABC} = 0, V_{TP} = 0$	0.08	nA
		$I_{ABC} = 0, V_{TP} = 36\text{V}$	0.3	nA
Differential Input Current		$I_{ABC} = 0, V_{DIFF} = 4\text{V}$	0.008	nA
Amplifier Bias Voltage	V_{ABC}		0.71	V
Slew Rate:	SR			
Maximum (Uncompensated)			75	V/ μs
Unity Gain (Compensated)			50	V/ μs
Open-Loop Bandwidth	BW_{OL}		2	MHz
Input Capacitance	C_I	$f = 1\text{ MHz}$	3.6	pF
Output Capacitance	C_O	$f = 1\text{ MHz}$	5.6	pF
Output Resistance	R_O		15	$\text{M}\Omega$
Input-to-Output Capacitance	C_{I-O}	$f = 1\text{ MHz}$	0.024	pF
Propagation Delay	t_{PHL}, t_{PLH}	$I_{ABC} = 500\mu\text{A}$	45	ns

Electrical Specifications For Equipment Design, $T_A = +25^\circ\text{C}$, Unless Otherwise Indicated

PARAMETERS	SYMBOL	TEST CONDITIONS	CA3080A LIMITS			UNITS
		$V_+ = 15\text{V}, V_- = -15\text{V}$ $I_{ABC} = 500\mu\text{A}$	MIN	TYP	MAX	
Input Offset Voltage	V_{IO}	$I_{ABC} = 5\mu\text{A}$	-	0.3	2	mV
			-	0.4	2	mV
		$T_A = -55$ to $+125^\circ\text{C}$	-	-	5	mV
Input Offset Voltage Change	ΔV_{IO}	$I_{ABC} = 500\mu\text{A}$ to $I_{ABC} = 5\mu\text{A}$	-	0.1	3	mV
Input Offset Current	I_{IO}		-	0.12	0.6	μA
Input Bias Current	I_I		-	2	5	μA
		$T_A = -55^\circ\text{C}$ to $+125^\circ\text{C}$	-	-	15	μA
Forward Transconductance (Large Signal)	g_M		7700	9600	12000	μmho
		$T_A = -55^\circ\text{C}$ to $+125^\circ\text{C}$	4000	-	-	μmho
Peak Output Current	I_{OM}	$I_{ABC} = 5\mu\text{A}, R_L = 0\Omega$	3	5	7	μA
		$R_L = 0\Omega$	350	500	650	μA
		$R_L = 0\Omega, T_A = -55^\circ\text{C}$ to $+125^\circ\text{C}$	300	-	-	μA

Specifications CA3080, CA3080A

Electrical Specifications For Equipment Design, $T_A = +25^\circ\text{C}$, Unless Otherwise Indicated (Continued)

PARAMETERS	SYMBOL	TEST CONDITIONS	CA3080A LIMITS			UNITS
		$V_+ = 15\text{V}, V_- = -15\text{V}$ $I_{ABC} = 500\mu\text{A}$	MIN	TYP	MAX	
Peak Output Voltage:		$I_{ABC} = 5\mu\text{A}, R_L = \infty$				
Positive	V_{+OM}		12	13.8	-	V
Negative	V_{-OM}		-12	-14.5	-	V
Positive	V_{+OM}	$R_L = \infty$	12	13.5	-	V
Negative	V_{-OM}		-12	-14.4	-	V
Amplifier Supply Current	I_A		0.8	1	1.2	mA
Device Dissipation	P_D		24	30	36	mW
Input Offset Voltage Sensitivity:						
Positive	$\Delta V_{IO}/\Delta V^+$		-	-	150	$\mu\text{V}/\text{V}$
Negative	$\Delta V_{IO}/\Delta V^-$		-	-	150	$\mu\text{V}/\text{V}$
Magnitude of Leakage Current		$I_{ABC} = 0, V_{TP} = 0$	-	0.08	5	nA
		$I_{ABC} = 0, V_{TP} = 36\text{V}$	-	0.3	5	nA
Differential Input Current		$I_{ABC} = 0, V_{DIFF} = 4\text{V}$	-	0.008	5	nA
Common-Mode Rejection Ratio	CMRR		80	110	-	dB
Common-Mode Input-Voltage Range	V_{ICR}		12 to -12	13.6 to -14.6	-	V
Input Resistance	R_I		10	26	-	k Ω

Electrical Specifications Typical Values Intended Only for Design Guidance, $T_A = +25^\circ\text{C}$, Unless Otherwise Specified

PARAMETERS	SYMBOL	TEST CONDITIONS	CA3080A TYP	UNITS
		$V_+ = 15\text{V}, V_- = -15\text{V}$ $I_{ABC} = 500\mu\text{A}$		
Amplifier Bias Voltage	V_{ABC}		0.71	V
Slew Rate:				
Maximum (Uncompensated)	SR		75	V/ μs
Unity Gain (Compensated)			50	V/ μs
Open-Loop Bandwidth	BW_{OL}		2	MHz
Input Capacitance	C_I	$f = 1\text{ MHz}$	3.6	pF
Output Capacitance	C_O	$f = 1\text{ MHz}$	5.6	pF
Output Resistance	R_O		15	M Ω
Input-to-Output Capacitance	C_{I-O}	$f = 1\text{ MHz}$	0.024	pF
Input Offset Voltage Temperature Drift	$\Delta V_{IO}/\Delta T$	$I_{ABC} = 100\mu\text{A}, T_A = -55^\circ\text{C} \text{ to } +125^\circ\text{C}$	3.0	$\mu\text{V}/^\circ\text{C}$
Propagation Delay	t_{PHL}, t_{PLH}	$I_{ABC} = 500\mu\text{A}$	45	ns

Typical Performance Curves

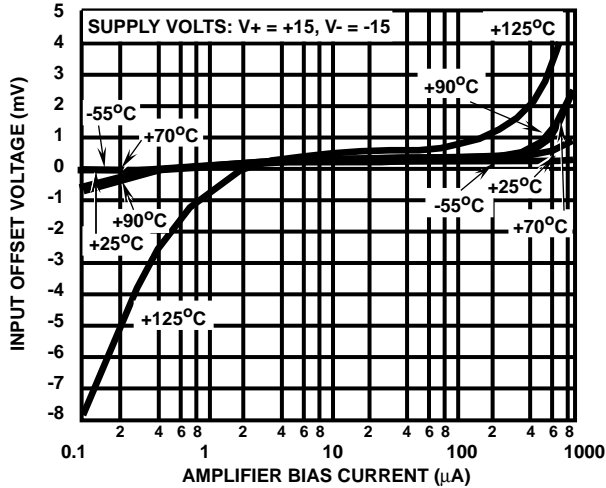

FIGURE 1. INPUT OFFSET VOLTAGE vs AMPLIFIER BIAS CURRENT

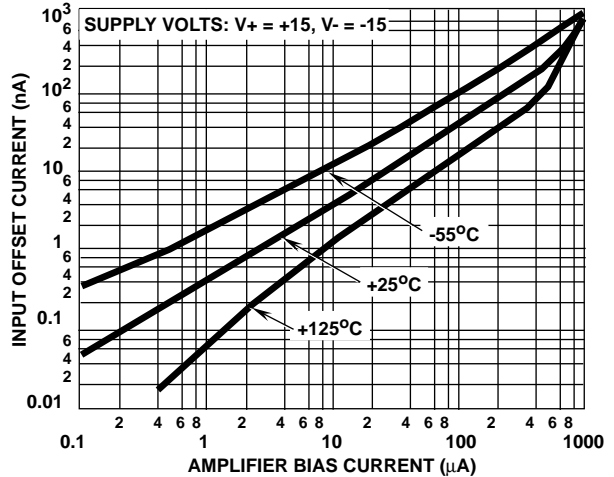

FIGURE 2. INPUT OFFSET CURRENT vs AMPLIFIER BIAS CURRENT

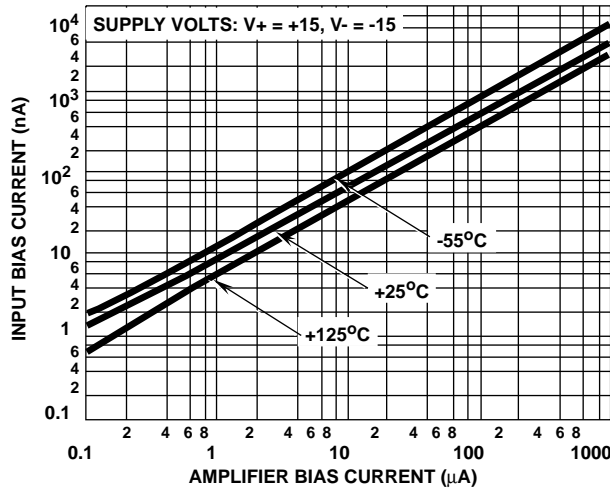

FIGURE 3. INPUT BIAS CURRENT vs AMPLIFIER BIAS CURRENT

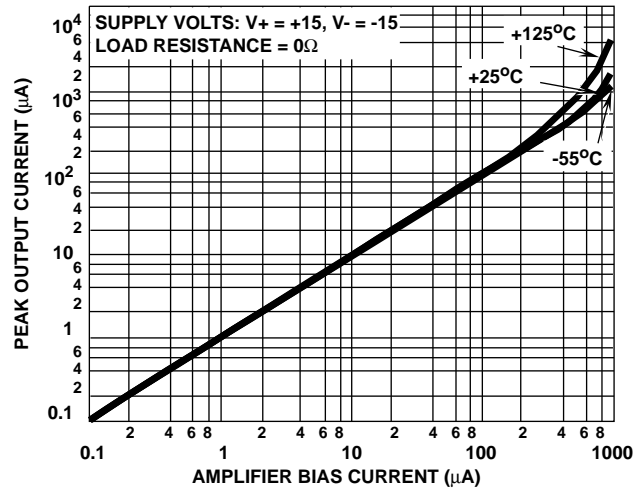

FIGURE 4. PEAK OUTPUT CURRENT vs AMPLIFIER BIAS CURRENT

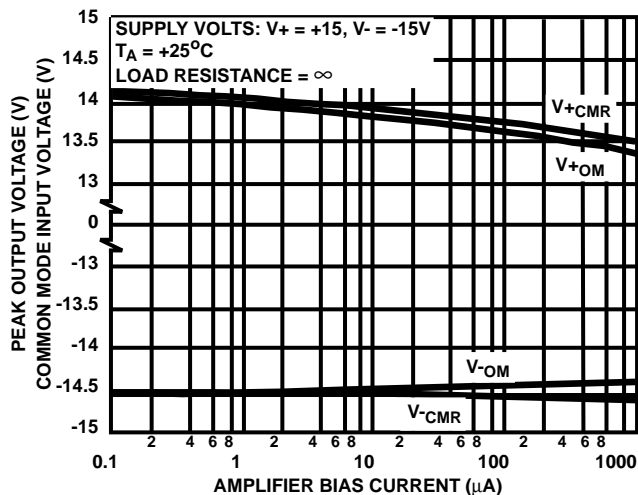

FIGURE 5. PEAK OUTPUT VOLTAGE vs AMPLIFIER BIAS CURRENT

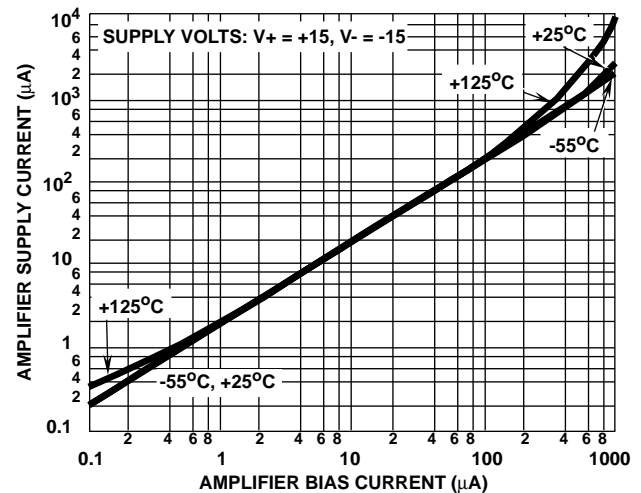

FIGURE 6. AMPLIFIER SUPPLY CURRENT vs AMPLIFIER BIAS CURRENT

Typical Performance Curves (Continued)

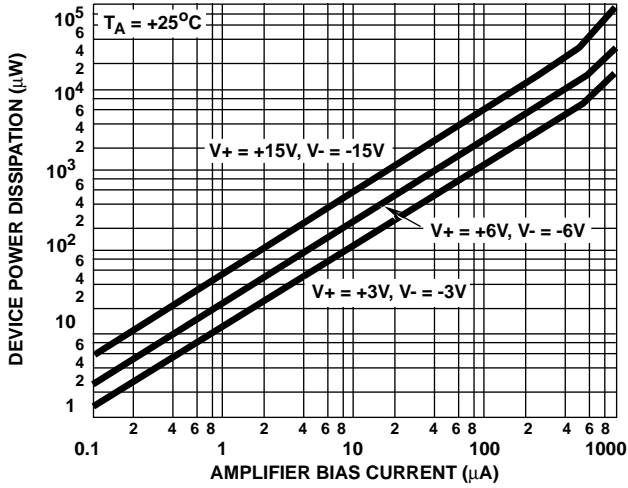

FIGURE 7. TOTAL POWER DISSIPATION vs AMPLIFIER BIAS CURRENT

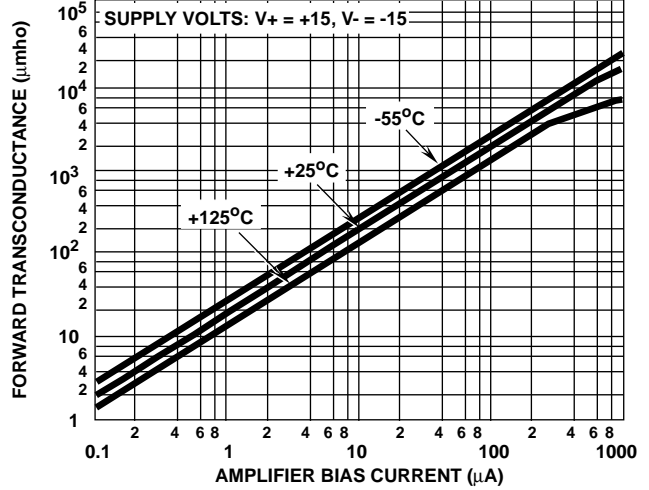

FIGURE 8. TRANSCONDUCTANCE vs AMPLIFIER BIAS CURRENT

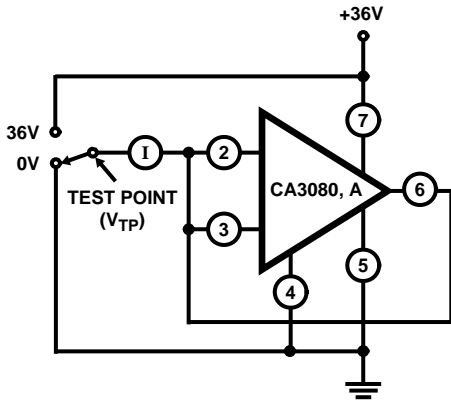

FIGURE 9. LEAKAGE CURRENT TEST CIRCUIT

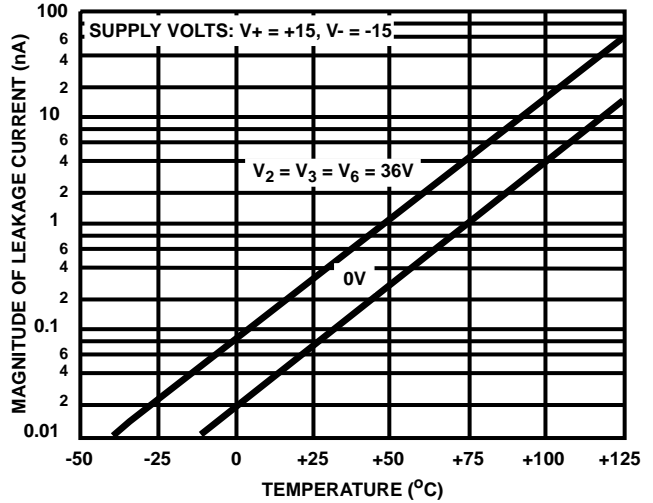

FIGURE 10. LEAKAGE CURRENT vs TEMPERATURE

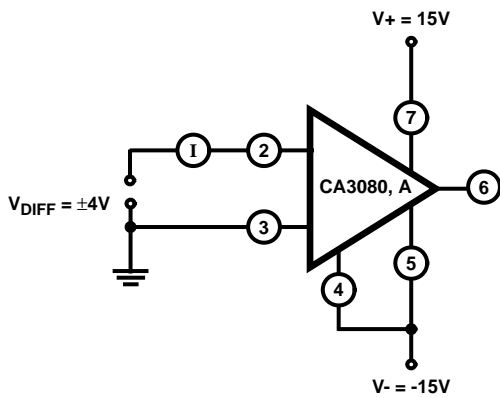

FIGURE 11. DIFFERENTIAL INPUT CURRENT TEST CIRCUIT

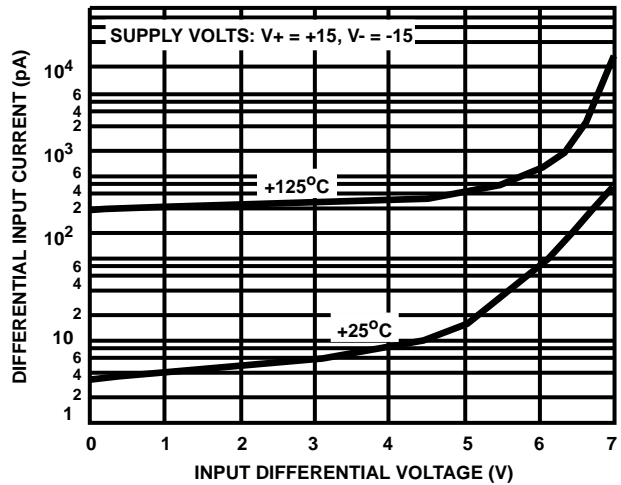

FIGURE 12. INPUT CURRENT vs INPUT DIFFERENTIAL VOLTAGE

Typical Performance Curves (Continued)

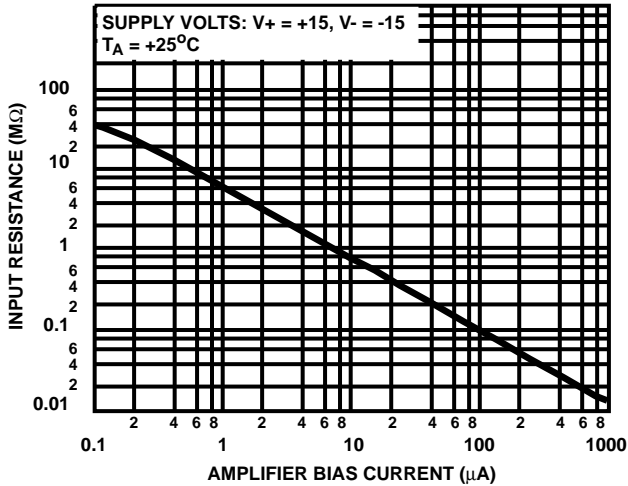

FIGURE 13. INPUT RESISTANCE vs AMPLIFIER BIAS CURRENT

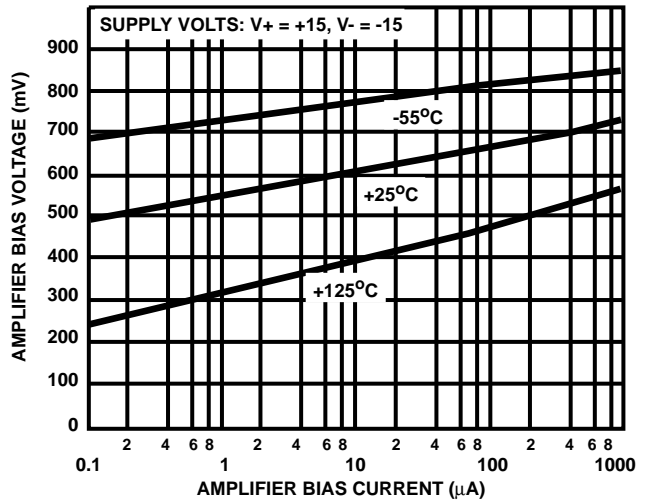

FIGURE 14. AMPLIFIER BIAS VOLTAGE vs AMPLIFIER BIAS CURRENT

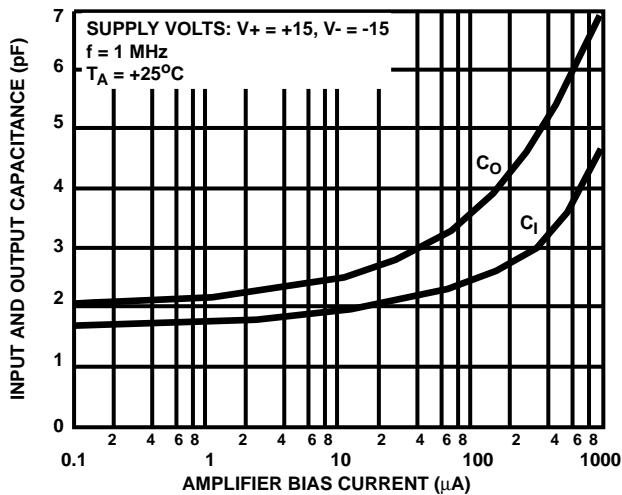

FIGURE 15. INPUT AND OUTPUT CAPACITANCE vs AMPLIFIER BIAS CURRENT

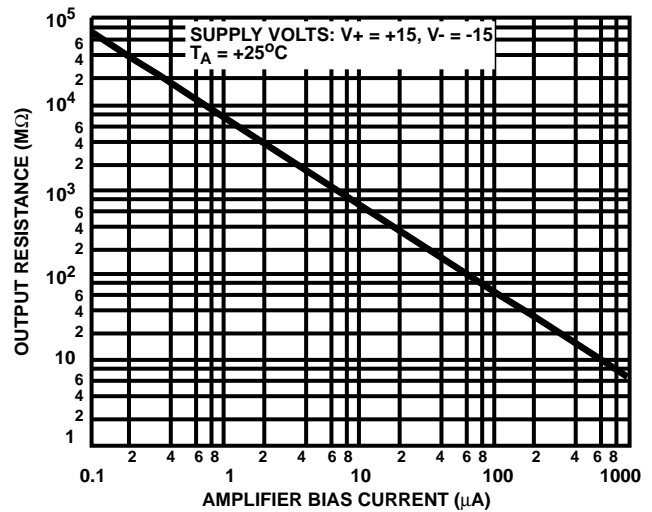

FIGURE 16. OUTPUT RESISTANCE vs AMPLIFIER BIAS CURRENT

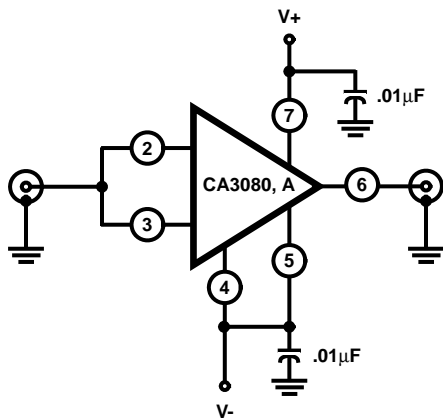

FIGURE 17. INPUT-TO-OUTPUT CAPACITANCE TEST CIRCUIT

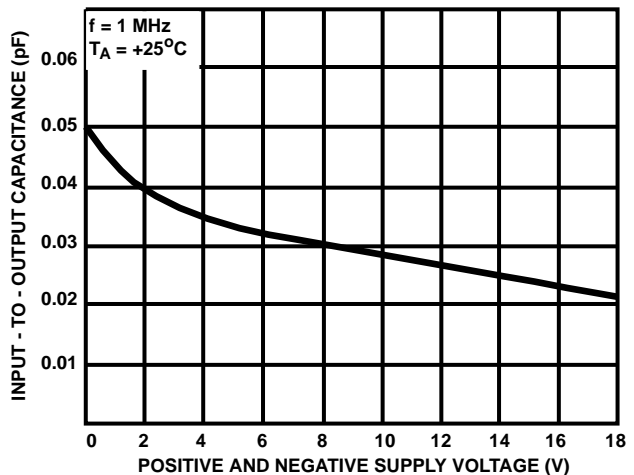

FIGURE 18. INPUT-TO-OUTPUT CAPACITANCE vs SUPPLY VOLTAGE

Applications

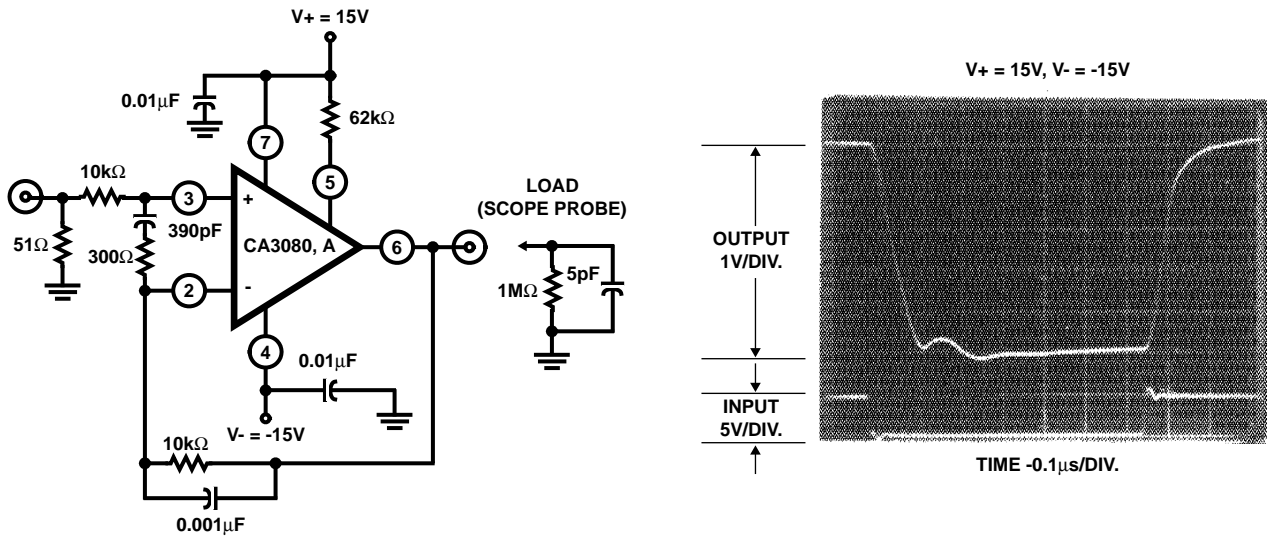

FIGURE 19. SCHEMATIC DIAGRAM OF THE CA3080 AND CA3080A IN A UNITY-GAIN VOLTAGE FOLLOWER CONFIGURATION AND ASSOCIATED WAVEFORM

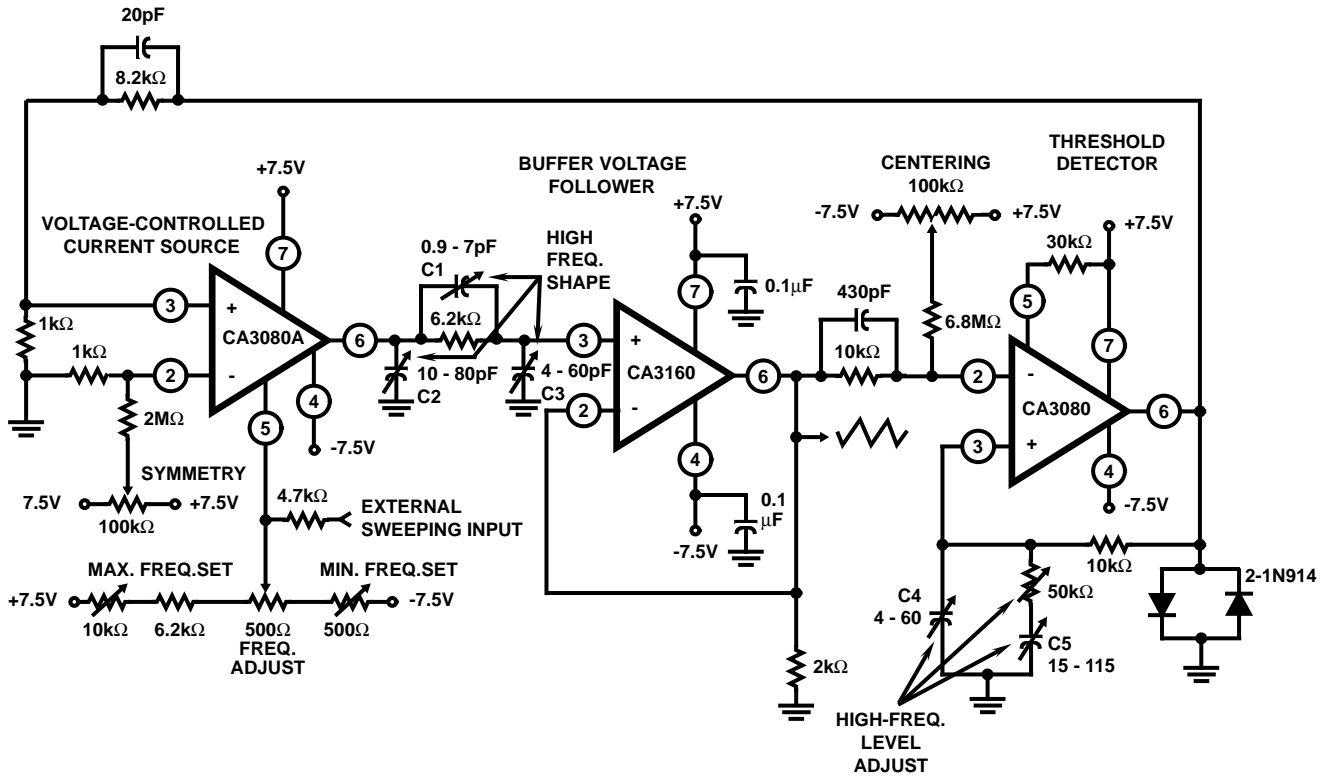
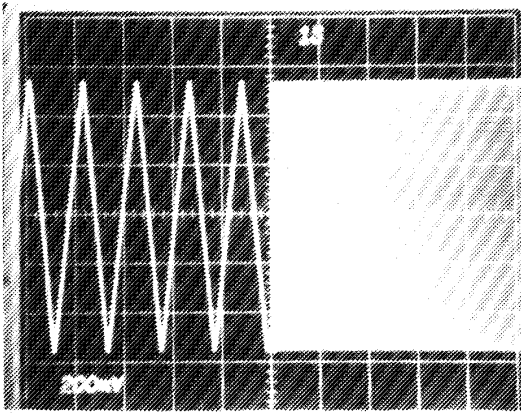
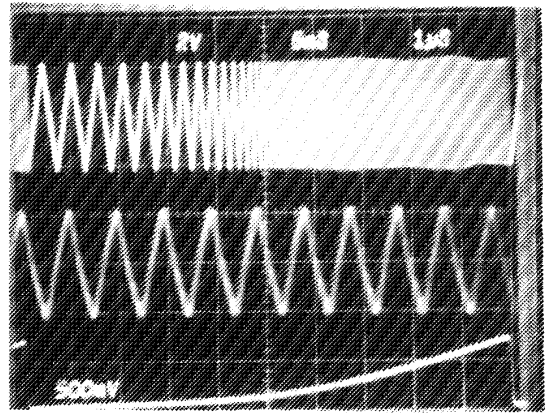

FIGURE 20. 1,000,000/1 SINGLE-CONTROL FUNCTION GENERATOR - 1MHz TO 1Hz

Applications (Continued)



(a) Two-Tone Output Signal From The Function Generator. A Square-Wave Signal Modulates The External Sweeping Input to Produce 1Hz and 1MHz, Showing the 1,000,000/1 Frequency Range of the Function Generator.



(b) Triple-Trace of the Function Generator Sweeping to 1MHz. The Bottom Trace is the Sweeping Signal and the Top Trace is the Actual Generator Output. The Center Trace Displays the 1MHz signal Via Delayed Oscilloscope Triggering of the Upper Swept Output Signal

FIGURE 21. FUNCTION GENERATOR DYNAMIC CHARACTERISTICS WAVEFORMS

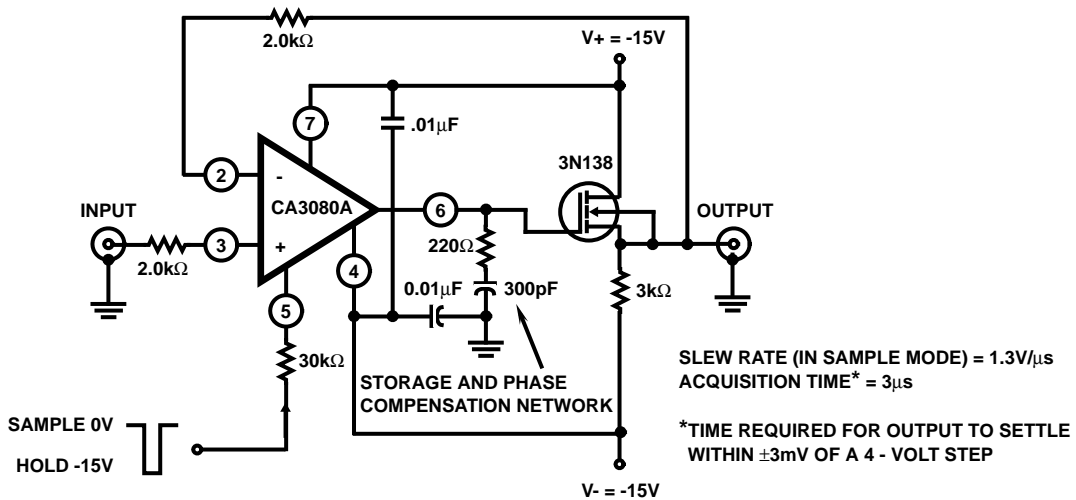

FIGURE 22. SCHEMATIC DIAGRAM OF THE CA3080A IN A SAMPLE-HOLD CONFIGURATION

Applications (Continued)

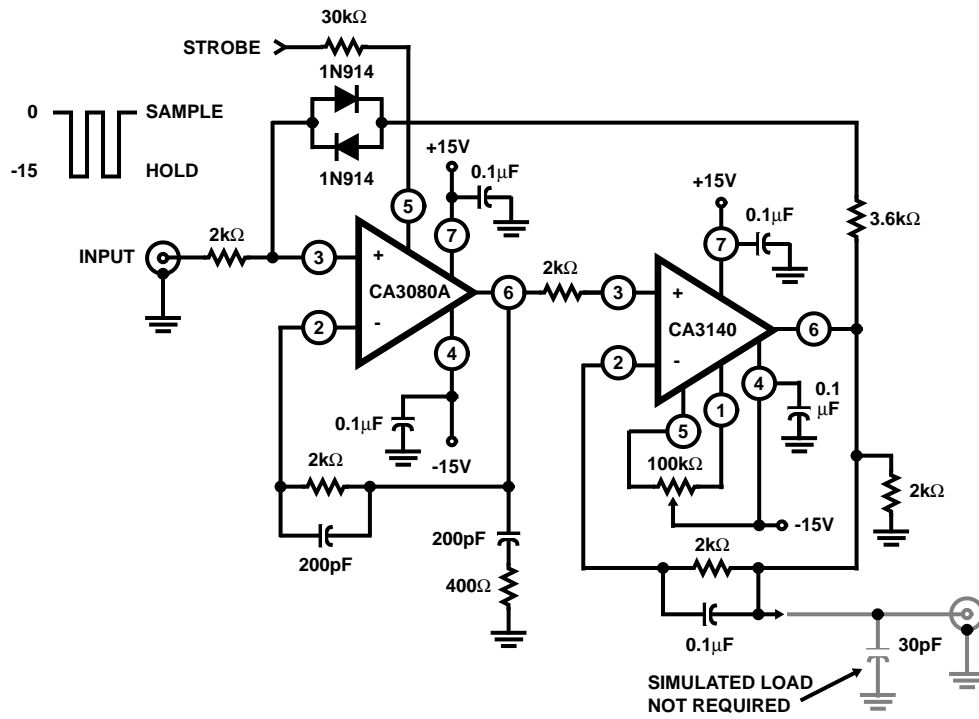
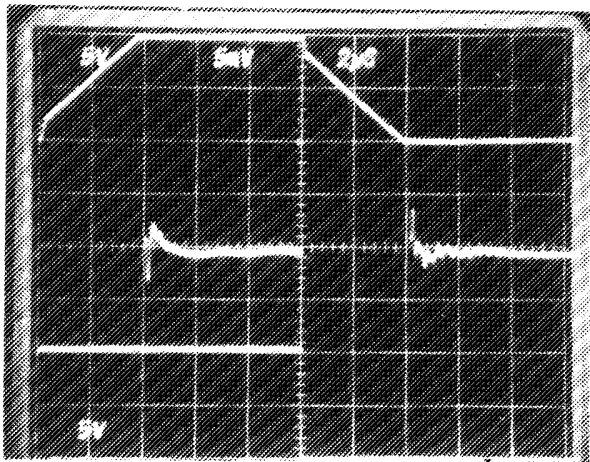

FIGURE 23. SAMPLE AND HOLD CIRCUIT



- Top Trace: Output Signal
(5V/Div. and 2μs/Div.)
- Bottom Trace: Input Signal
(5V/Div. and 2μs/Div.)
- Center Trace: Difference of Input and Output Signals Through
Tektronix Amplifier 7A13
(5mV/Div. and 2μs/Div.)

FIGURE 24. LARGE SIGNAL RESPONSE AND SETTLING TIME FOR CIRCUIT SHOWN IN FIGURE 23

Applications (Continued)

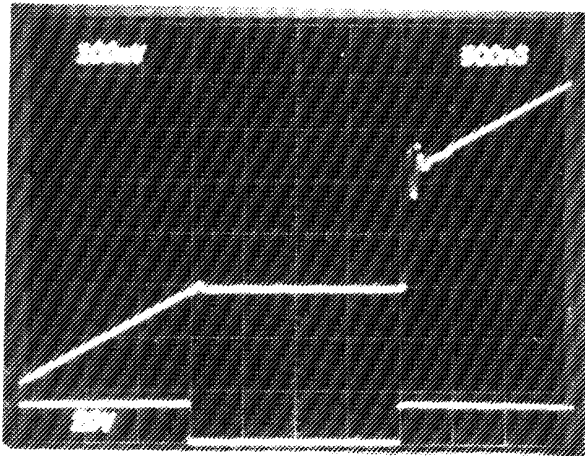

Top Trace: System Output
(100mV/Div. and 500ns/Div.)

Bottom Trace: Sampling Signal
(20V/Div. and 500ns/Div.)

FIGURE 25. SAMPLING RESPONSE FOR CIRCUIT SHOWN IN FIGURE 23

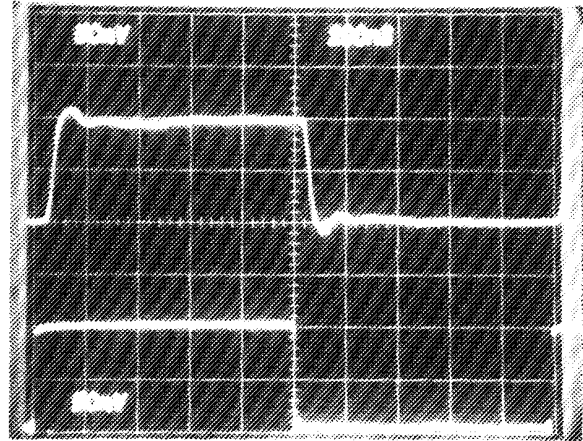

Top Trace: Output
(50mV/Div. and 200ns/Div.)

Bottom Trace: Input
(50mV/Div. and 200ns/Div.)

FIGURE 26. INPUT AND OUTPUT RESPONSE FOR CIRCUIT SHOWN IN FIGURE 23

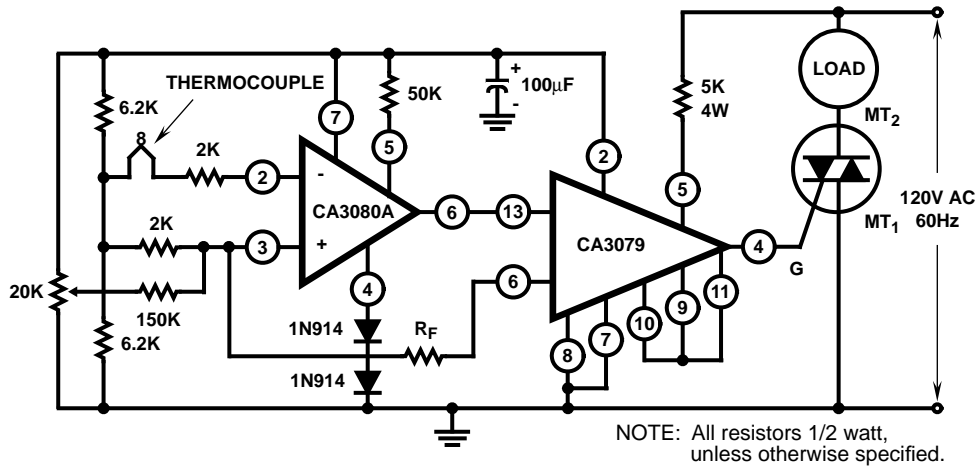

FIGURE 27. THERMOCOUPLE TEMPERATURE CONTROL WITH CA3079 ZERO VOLTAGE SWITCH AS THE OUTPUT AMPLIFIER

Applications (Continued)

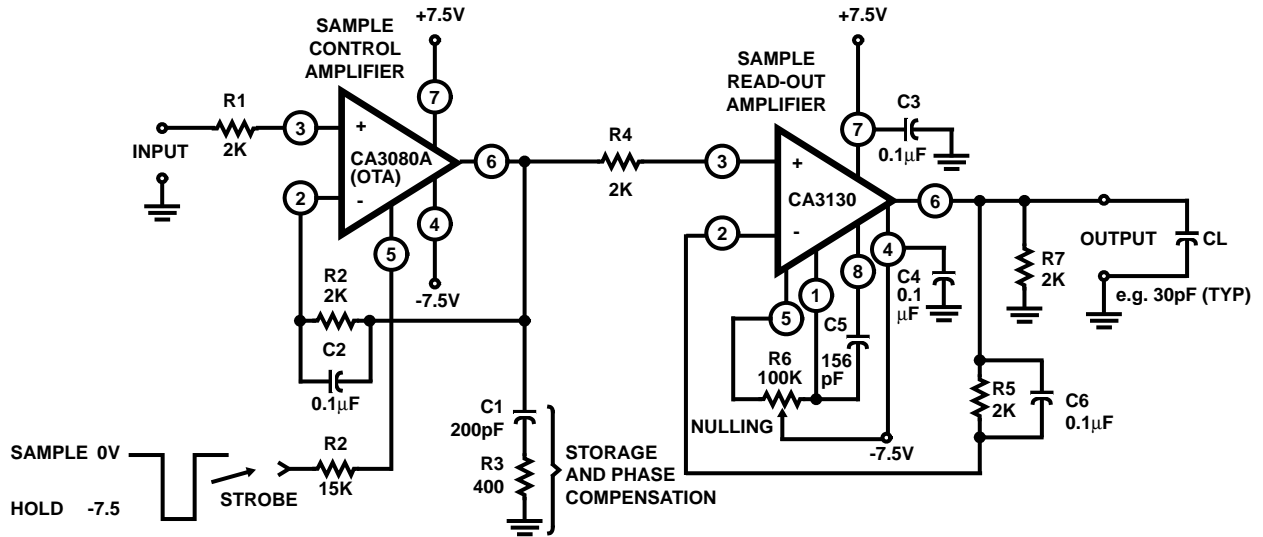
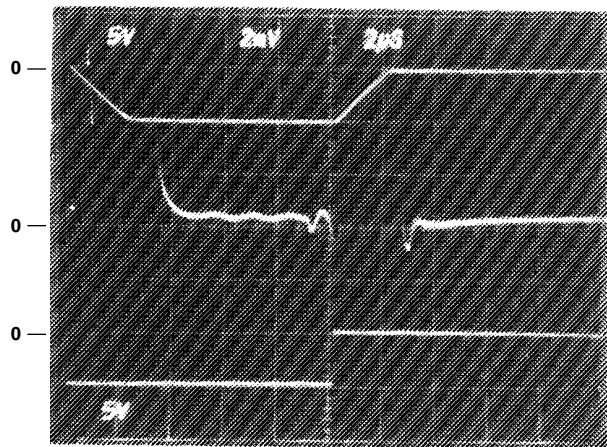
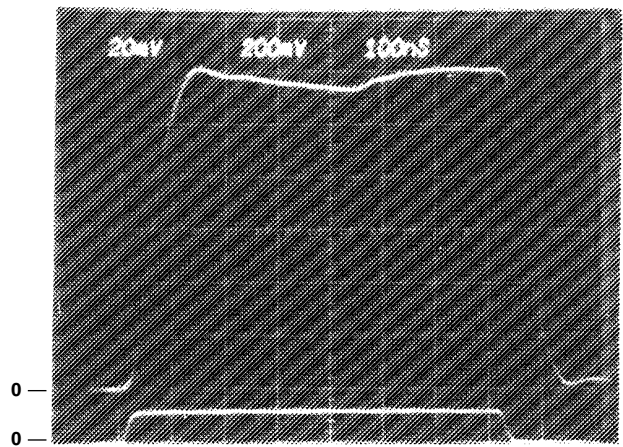

FIGURE 28. SCHEMATIC DIAGRAM OF THE CA3080A IN A SAMPLE-HOLD CIRCUIT WITH BIMOS OUTPUT AMPLIFIER



Top Trace: Output (5V/Div. and 2µs/Div.)
 Center Trace: Differential Comparison of Input and Output (2mV/Div. and 2µs/Div.)
 Bottom Trace: Input (5V/Div. and 2µs/Div.)

FIGURE 29. LARGE-SIGNAL RESPONSE FOR CIRCUIT SHOWN IN FIGURE 28



Top Trace: Output (20mV/Div. and 100ns/Div.)
 Bottom Trace: Input (200mV/Div. and 100ns/Div.)

FIGURE 30. SMALL-SIGNAL RESPONSE FOR CIRCUIT SHOWN IN FIGURE 28

Applications (Continued)

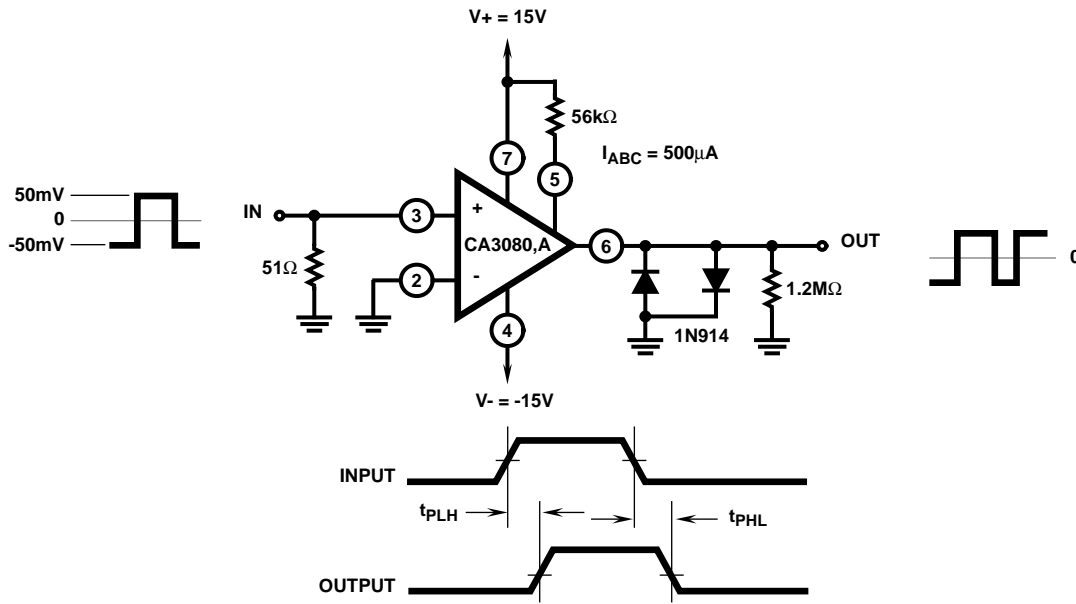

FIGURE 31. PROPAGATION DELAY TEST CIRCUIT AND ASSOCIATED WAVEFORMS