

LED Driver for Light Spot Displays

UAA 170

Bipolar IC

IC for driving 16 light emitting diodes. Depending on the input voltage, the individual LEDs are driven within one row in form of a light spot. The UAA 170 provides a linear relation between control voltage and the driven LED.

By using an appropriate circuitry, the brightness of the LEDs can be varied and the crossing over of the light spot can be set between "smooth" and "abrupt". By connecting two ICs in parallel, up to 30 LEDs can be driven.

Type	Ordering Code	Package
UAA 170	Q67000-A940	P-DIP-16

Absolute Maximum Ratings

Parameter	Symbol	Limit Values	Unit
Supply voltage	V_S	18	V
Input voltages	V_{11}, V_{12}, V_{13}	6	V
Load current	I_{14}	5	mA
Junction temperature	T_j	150	°C
Storage temperature range	T_{stg}	- 40 to 125	°C
Thermal resistance (system-air)	$R_{th SA}$	90	K/W

Operating Range

Supply voltage (LED red) ¹⁾	V_S	11 to 18	V
Ambient temperature	T_A	- 25 to 85	°C

1) The lower limit only applies to an LED forward voltage of approx. 1.5 V (red LEDs); the lower limit increases with higher forward voltage

Characteristics

$V_S = 12\text{ V}$; $T_A = 25^\circ\text{C}$

Parameter	Symbol	Limit Values			Unit
		min.	typ.	max.	
Current consumption ($I_{14} = 0$; $I_{16} = 0$)	I_S	2	4	10	mA
Control input current	I_{11}	-2			μA
Reference input current	I_{12}, I_{13}	-2			μA
Voltage difference	$\Delta V_{12/13}$	1.4		6.0	V
Voltage difference for smooth light transition	$\Delta V_{12/13}$	1.4			V
Voltage difference for abrupt light transition	$\Delta V_{12/13}$	4			V
Voltage difference	$\Delta V_{12/13}$	4			V
Stabilized voltage $I_{14} = 300\ \mu\text{A}$ $I_{14} = 5\ \text{mA}$	V_{14}		5.0	6.0	V
	V_{14}	4.5			V
Reference input voltage	$V_{\text{REF max}}$	1.4		6.0	V
	$V_{\text{REF min}}$	0		4.6	V
Tolerance of forward voltages of LEDs, mutually	ΔV_D			0.5	V
Output current for LEDs	ΣI_D		25		mA

Scale Display with Light Emitting Diodes

Scale displays by means of a wandering light spot are particularly suitable for indicating approximate values. Applications of this kind are level sensors, VU-meters, tachometers, radio scales etc. When applying the displays in measuring equipment, multicolored light emitting diodes can be used as range limitation. Ring scales are obtained by a circular arrangement of the diodes. The IC UAA 170 has been especially developed for driving a scale of 16 LEDs.

The input voltages at pins 11, 12 and 13 are freely selectable between 0 and 6 V. Any kind of adjustment becomes possible by suitable voltage drivers. The DC value $V_{control}$ is always assigned to a certain spot of the diode chain.

The voltage difference between pins 12 and 13 thereby corresponds to the possible indication range. $\Delta V_{12/13}$ defines at the same time the light transition between two diodes. With $\Delta V_{12/13}$ approx. 1.4 V, the light point glides smoothly along the scale. With increasing voltage difference, the passage becomes more abrupt. With $\Delta V_{12/13}$ approx. 4 V, the light point jumps from diode to diode.

Input voltages beyond the selected indication range cause the diodes D1 or D16 respectively, to light up, identifying only that the range has been exceeded.

Block Diagram

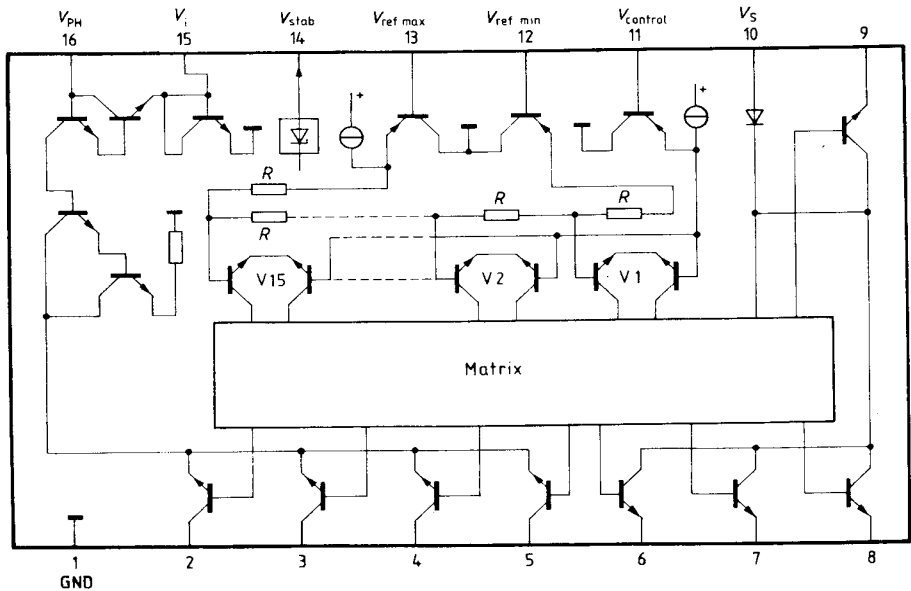

Display with smooth transition UAA 170

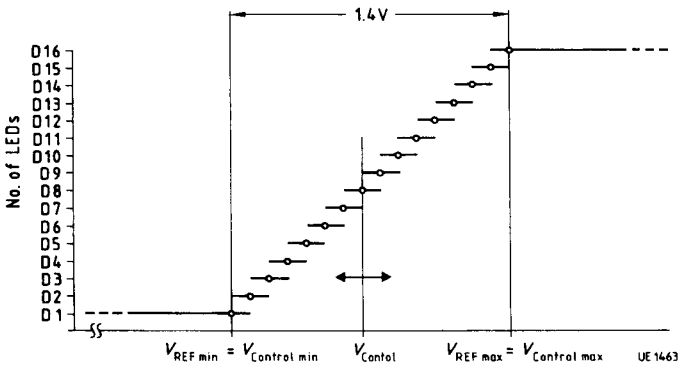

Display with abrupt transition UAA 170

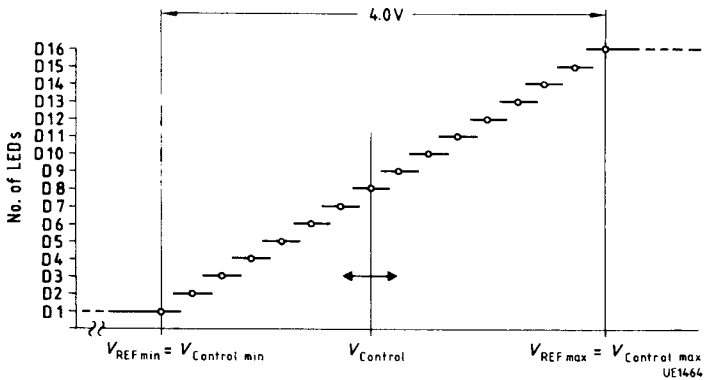

Brightness Control

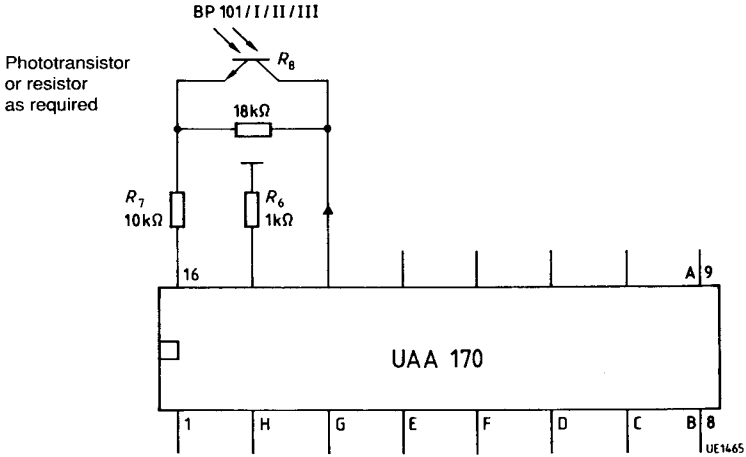

Pins 14, 15, and 16 serve to determine the diode current. Corresponding to the desired light intensity, the forward current of the diodes is linearly variable in the range I_f approx. 0 to 50 mA. The resistance at pin 15 defines the adjusting range. The resistances between pin 14 and 16 determine the current.

With the aid of a phototransistor, such as BP 101, the light intensity of the LEDs can be adjusted to the light fluctuations of the environment.

Diode current versus base emitter resistance

$V_S = 12\text{ V}; T_A = 25\text{ }^\circ\text{C}; V_{14} = 5.4\text{ V};$ red LEDs

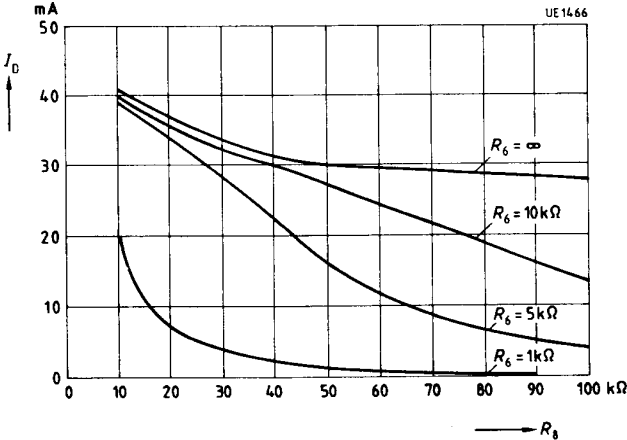

Operation of less than 16 LEDs

Control of 9 LEDs

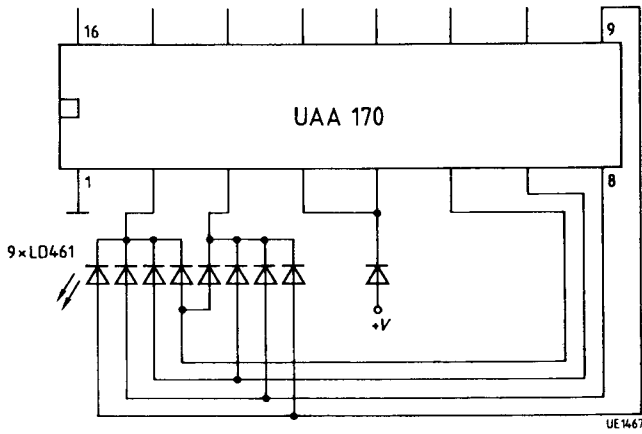

Control of 11 LEDs

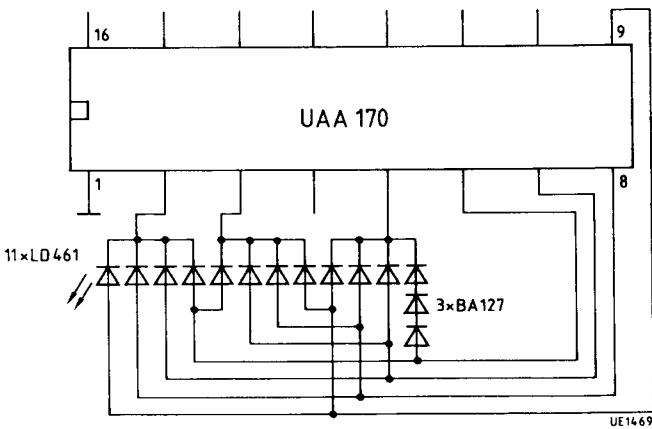

Application Circuit for the Control of 30 LEDs with 2 × UAA 170

Range of control voltage $V_{control} = 0$ to 5 V

Voltage difference $V_{12/13} = 2 \times 1.2 \text{ V} = 2.4 \text{ V}$

Since the diodes D16 or D17 are permanently lit when the maximum or minimum voltages V_{13} or V_{12} adjusted by R_3, R_4, R_5 , are exceeded or fall short, the diodes should be covered, if necessary.

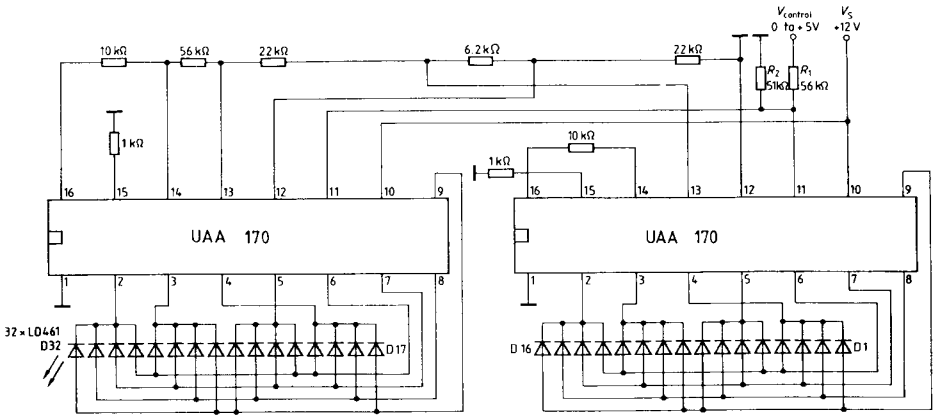

The figure shows an expansion of the circuit to 30 diodes with 2 ICs UAA 170. The diodes D16 or D17 are permanently lit when the reciprocal absolute ratings are exceeded. They should be covered. The reference voltage $\Delta V_{12/13} = 2 \times 1.2 = 2.4 \text{ V}$ is derived from a stabilized DC voltage of typ. 5 V available at pin 14. A resistance of 6.2 kΩ provides an overlapping of the ranges in order to ensure a smooth transition from D15 to D18. The control voltage $V_{control}$ is forwarded in a parallel mode to pins 11 via a divider $R_1 : R_2$. The voltage divider is to be dimensioned according to the desired input voltage. With a divider current of $I = 100 \mu\text{A}$ and a control voltage of $V_{control} = 10 \text{ V}$, the following is valid:

$$R_2 = \frac{\Delta V_{12/13}}{I} = \frac{2.4}{0.1} = 24 \text{ k}\Omega \text{ and}$$

$$R_1 = \frac{V_{control} - \Delta V_{12/13}}{I} = \frac{7.6}{0.1} = 76 \text{ k}\Omega$$

The nearest standard value is $R_1 = 75 \text{ k}\Omega$. The voltage difference for switching an incremental

$$\text{step is then } \Delta V_{control} = \frac{10 \text{ V}}{30} = 0.16 \text{ V.}$$

Copyright © Each Manufacturing Company.

All Datasheets cannot be modified without permission.

This datasheet has been download from :

www.AllDataSheet.com

100% Free DataSheet Search Site.

Free Download.

No Register.

Fast Search System.

www.AllDataSheet.com